

MONTÁŽNY NÁVOD

MODUL 4DV

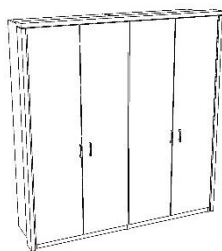

- 1** Skôr ako začneme montovať si roztriedime bočnice a strednicu skrine. Strednica má predvŕtané diery skrz. Do predvŕtaných otvorov bočnice skrine naskrutkujeme „ťahlo jednostranné“ a vložíme drevené kolíky. Do strednice namontujeme „ťahlo obojstranné“ a vložíme kolíky z oboch strán.



ťahlo jednostranné



ťahlo obojstranné



drevený kolík

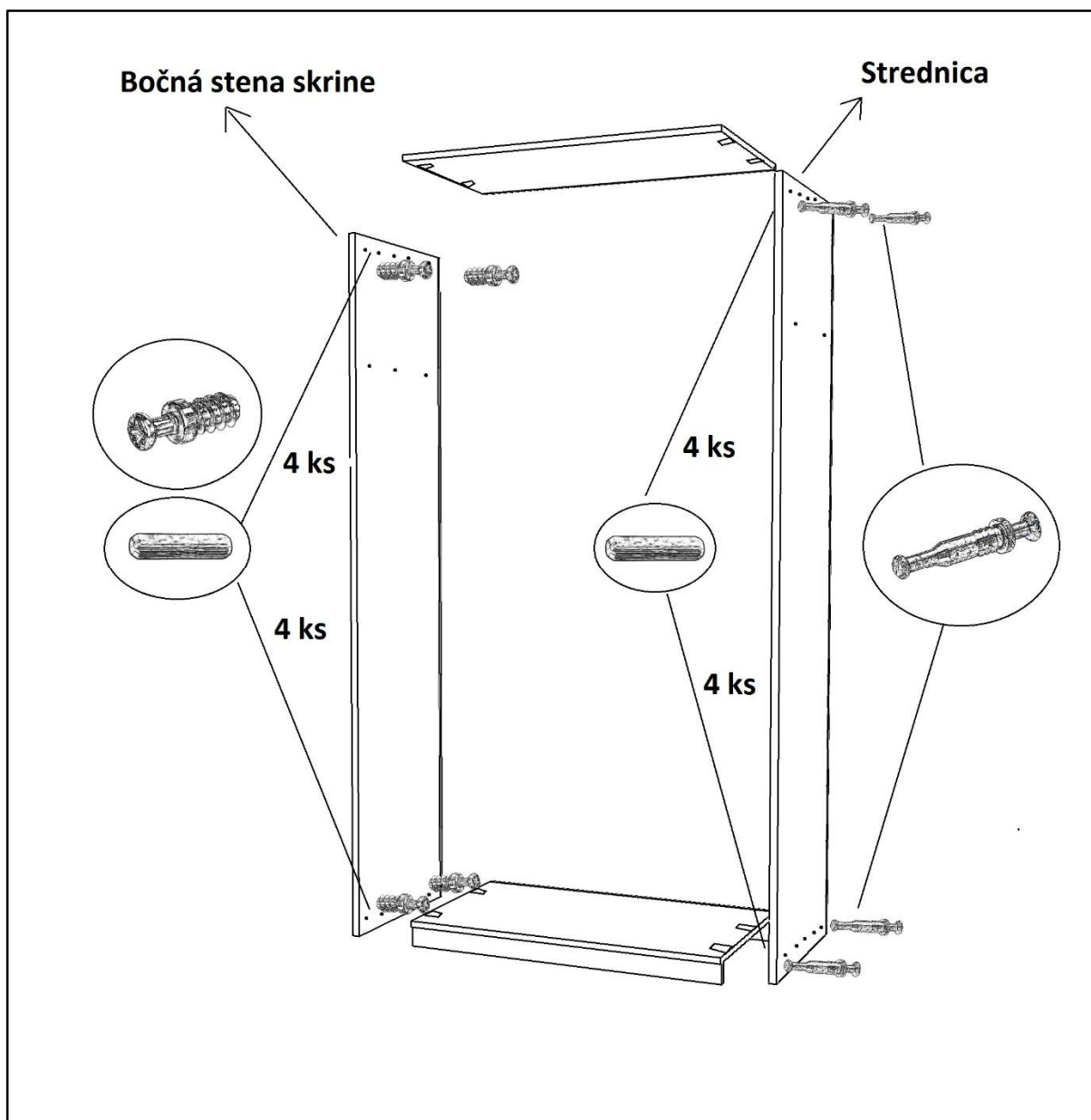

- 2** Bočnicu spojíme so spodným soklom zatahnutím excentrov. Vložíme zadný sololit do drážky, priložíme strednicu a zatahneme excentre. Nasadíme vrchný top skrine a zatahneme excentre. Do zadného sololitu vložíme spojku a priskrutkujeme skrutkou 4/16 s poglobatou hlavou pritiahneme sololit a poistíme proti posunutiu samoreznou skrutkou 4/16.



spojka



samorezná skrutka 4/16mm

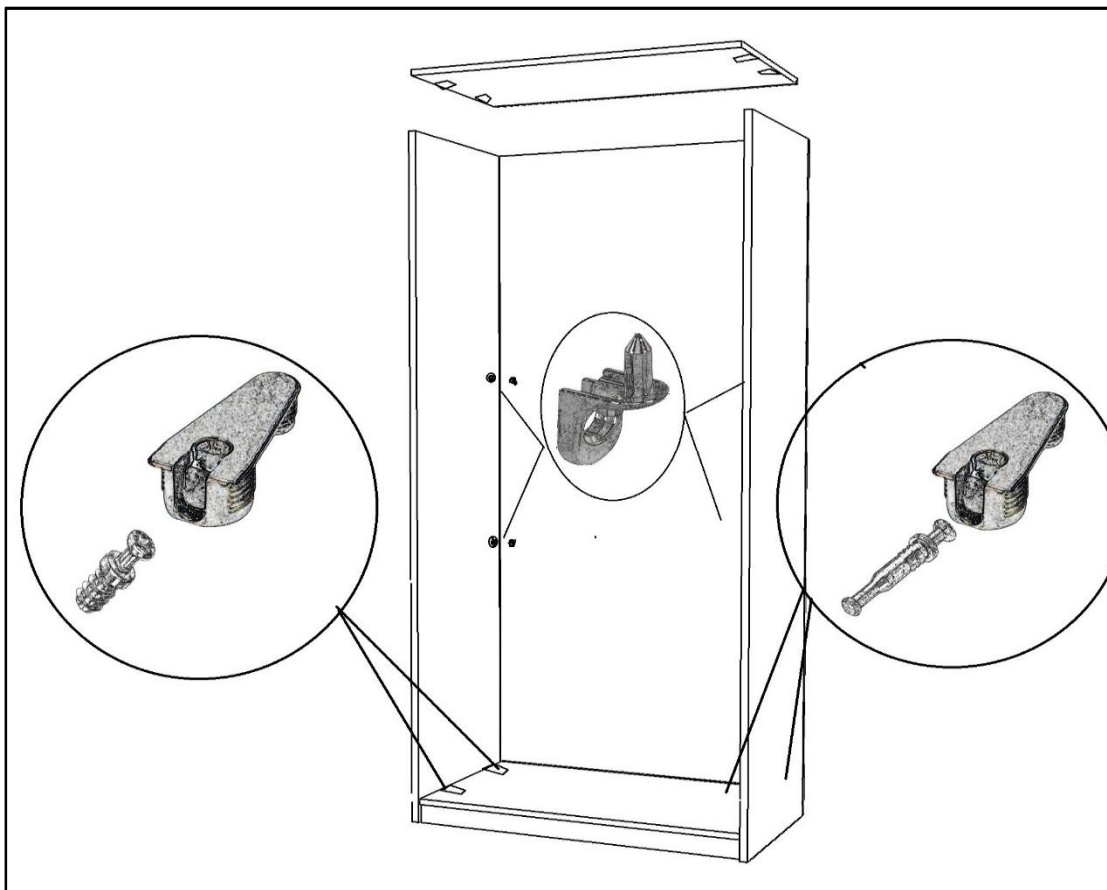

- 3** Do predvrtaných otvorov bočnice skrine naskrutkujeme „ťahlo jednostranné“, vložíme drevené kolíky a celý postup opakujeme.

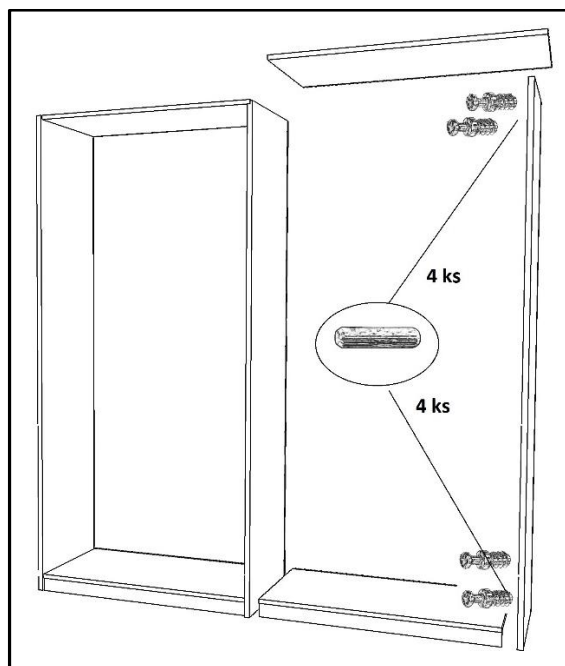

- 4 Na krajné dvere namontujeme NK záves naložený a do vnútorných dverí NK záves polonaložený.

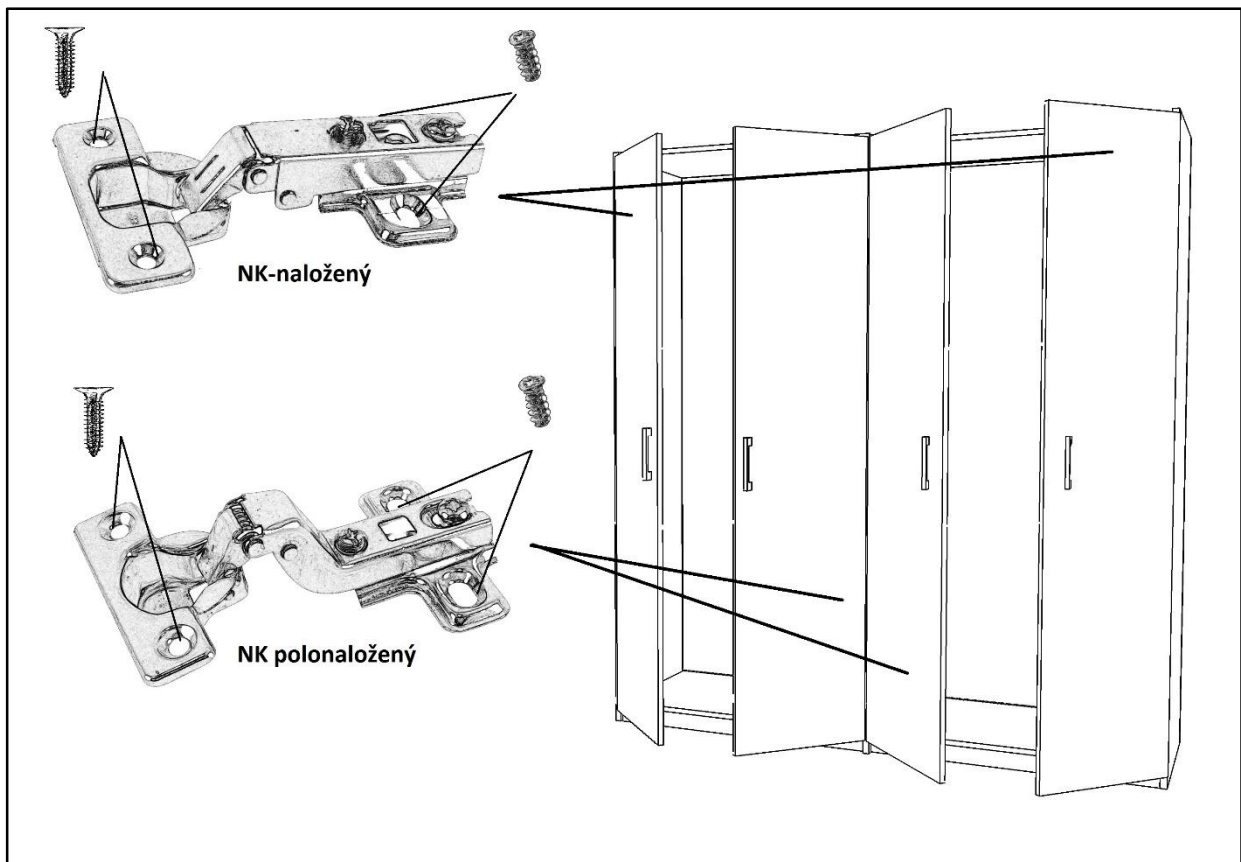
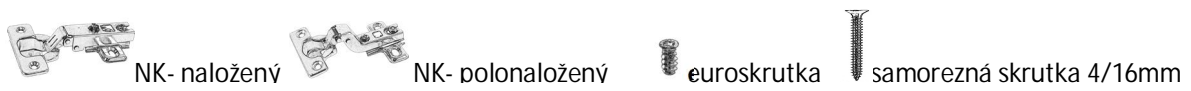

- 5 Pomocou samorezných skrutiek namontujeme okrasnú rampu skrine.

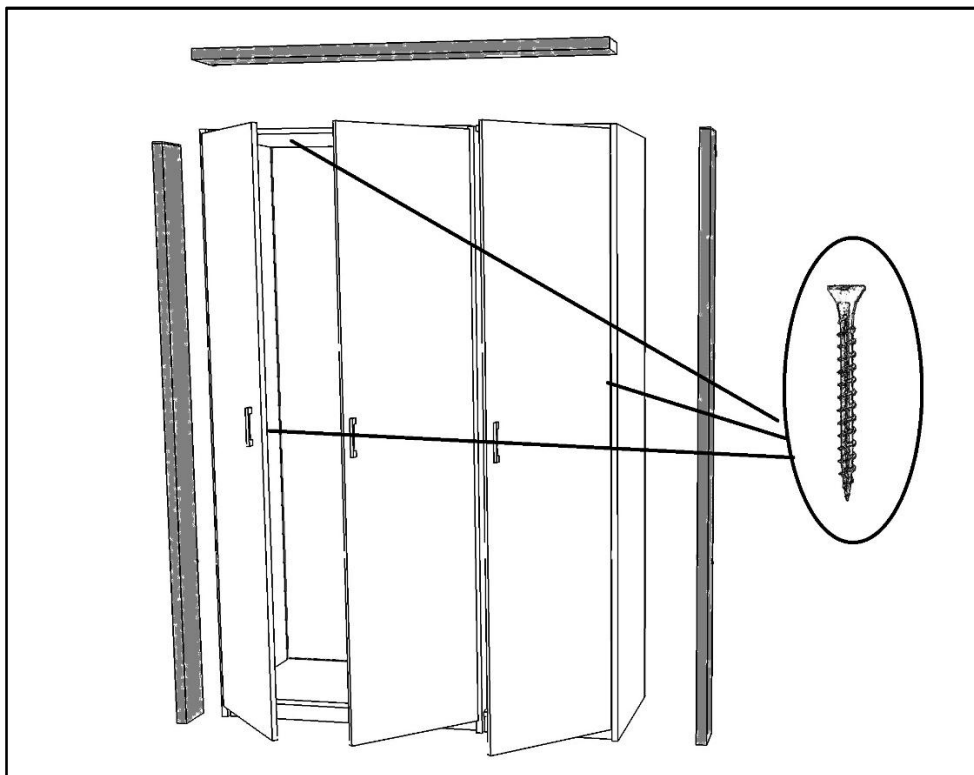
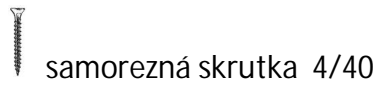

6 Na záver, nasadíme podperky políc do korpusu skrine, podpery tyče a namontujeme madlá na dvere .



podpera tyče







podperka police

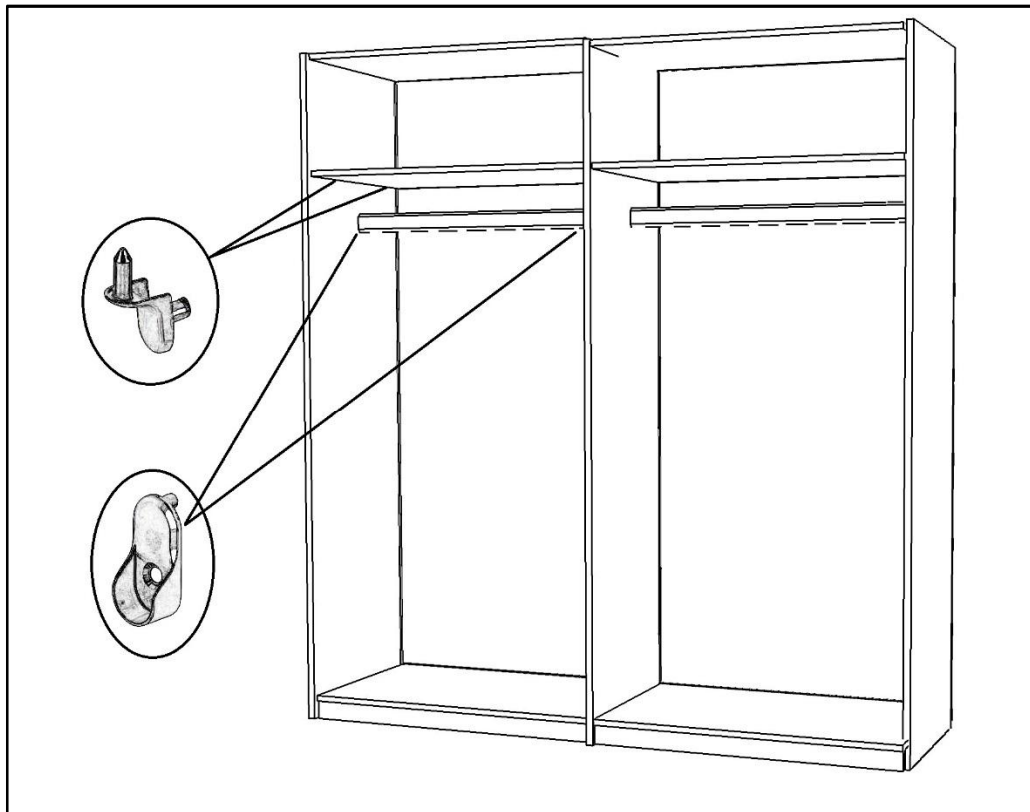

↓ samorezná skrutka 3,5/16mm



Montážny balíček obsahuje:

	samorezná skrutka 4/16 mm	40 ks		tiahlo jednostranné	8 ks
	sam. polgul. hlava skrutka 4/16	8 ks		samorezná skrutka 4/40	8 ks
	samorezná skrutka 3,5/20	8 ks		samorezná skrutka 3,5/16	8 ks
	NK- naložený	8 ks		drevený kolík	22 ks
	NK-polonaložený	8 ks		podpera tyče	4 ks
	podperka police	16 ks		spojka	8 ks
	euroskrutka	32 ks		tiahlo obojstranné	4 ks

Pozn: Pri jednotlivých rozmeroch sa môže obsah montážneho balíčka líšiť!